



INSTALLATION AND OPERATING INSTRUCTIONS

IHP Induction Hot Plate

Model Numbers: IHP-1, IHP-2, IHP-4

**INTENDED FOR OTHER THAN HOUSEHOLD USE
RETAIN THIS MANUAL FOR FUTURE REFERENCE
UNIT MUST BE KEPT CLEAR OF COMBUSTIBLES AT ALL TIMES**

This equipment has been engineered to provide you with year-round dependable service when used according to the instructions in this manual and standard commercial kitchen practices.

IMPORTANT FOR FUTURE REFERENCE

Please complete this information and retain this manual for the life of the equipment. For Warranty Service and/or Parts, this information is required.

Model Number

Serial Number

Date Purchased



WARNING: For your safety do not store or use gasoline or other flammable vapors or liquids in the vicinity of this or any other appliance. Keep the area free and clear of combustibles. (See ANZI Z83.14B, 1991)



WARNING: Improper installation, operation, service or maintenance can cause property damage, injury or death. Read and understand these instructions thoroughly before positioning, installing, maintaining or servicing this equipment.



P/N 8894000 03/13

APW WYOTT Foodservice Equipment Company

P.O. Box 1829
Cheyenne, WY 82003

+1 (307) 634-5801 Phone
+1(307) 637-8071 Fax

+1 (800) 752-0863 Toll Free
www.apwwyott.com



APW Wyott takes pride in the design and quality of our products. When used as intended and with proper care and maintenance, you will experience years of reliable operation from this equipment. To ensure best results, it is important that you read and follow the instructions in this manual carefully. Installation and start-up should be performed by a qualified installer who thoroughly read, understands and follows these instructions.



If you have questions concerning the installation, operation, maintenance or service of this product, write Technical Service Department APW/Wyott Foodservice Equipment Company, P.O. Box 1829, Cheyenne, WY 82003.



SAFETY PRECAUTIONS



Before installing and operating this equipment be sure everyone involved in its operation is fully trained and is aware of all precautions. Accidents and problems can result by a failure to follow fundamental rules and precautions.



The following words and symbols, found in this manual, alert you to hazards to the operator, service personnel or the equipment. The words are defined as follows.



 **DANGER:** This symbol warns of imminent hazard which will result in serious injury or death. 



 **WARNING:** This symbol refers to a potential hazard or unsafe practice, which could result in serious injury or death. 



 **CAUTION:** This symbol refers to a potential hazard or unsafe practice, which may result in minor or moderate injury or product or property damage. 



 **NOTICE:** This symbol refers to information that needs special attention or must be fully understood even though not dangerous. 



 **CAUTION:** These models are designed, built, and sold for commercial use. If these models are positioned so the general public can use the equipment make sure that cautions, warnings, and operating instructions are clearly posted near each unit so that anyone using the equipment will use it correctly and not injure themselves or harm the equipment. 



 **WARNING: *SHOCK HAZARD*** - Do not open any panels that require the use of tools. 



 **WARNING:** Improper installation, adjustment, alteration, service or maintenance can cause property damage, injury or death. Read the Installation, Operating and Maintenance Instructions thoroughly before installing or servicing this equipment. 



 **NOTICE:** The unit when installed, must be electrically grounded and comply with local codes, or in the absence of local codes, with the national electrical code ANSI/NFPA70- latest edition. Canadian installation must comply with CSA-STANDARD C.22.2 Number 0 M1982 General Requirements-Canadian Electrical Code Part II, 109-M1981- Commercial Cooking Appliances. 

 **NOTICE:** Local codes regarding installation vary greatly from one area to another. The National Fire Protection Association, Inc. states in its NFPA96 latest edition that local codes are "Authority Having Jurisdiction" when it comes to requirement for installation of equipment. Therefore, installation should comply with all local codes. 

 **WARNING:** Check the data plate on this unit before installation. Connect the unit only to the voltage and frequency listed on the data plate. Connect only to 1 or 3 phase as listed on the data plate. 

 **WARNING:** Disconnect device from electrical power supply and place a Tag Out-Lockout on the power plug, indicating that you are working on the circuit. 

 **CAUTION:** Maintenance & repair should be handled by a factory authorized agent. Before doing any maintenance or repair, contact APW Wyott. 

 **NOTICE:** Install according to the spacing requirements listed in the installation section of this manual. We strongly recommend having a competent professional install this equipment. A licensed electrician should make the electrical connections and connect power to the unit. Local codes should always be used when connecting these units to electrical power. In the absence of local codes, use the latest version of the National Electrical Code. 

CONTENTS

<u>Description</u>	<u>Page</u>	<u>Description</u>	<u>Page</u>
Safety Precautions.....	2	Operating Instructions.....	8
General Installation Instructions.....	4	Exploded View.....	9
Cleaning.....	5	Parts List	10
Troubleshooting / Service.....	5	Wiring	11
Use and Care / Safeguards.....	6	Notes.....	12
Safety Devices / Suitable Pots/Pans. 7		Warranty	13

LOCATION OF DATA PLATE

The data plate for the IHP is located on the back of the unit.

IMMEDIATELY INSPECT FOR SHIPPING DAMAGE

All containers should be examined for damage before and during unloading. The freight carrier has assumed responsibility for its safe transit and delivery. If equipment is received damaged, either apparent or concealed, a claim must be made with the delivering carrier.

- A) Apparent damage or loss must be noted on the freight bill at the time of delivery. It must then be signed by the carrier representative (Driver). If this is not done, the carrier may refuse the claim. The carrier can supply the necessary forms.
- B) Concealed damage or loss if not apparent until after equipment is uncrated, a request for inspection must be made to the carrier within 15 days. The carrier should arrange an inspection. Be certain to hold all contents and packaging material.

Installation and start-up should be performed by a qualified installer who thoroughly read, understands and follows these instructions.

How does your Induction Hot Plate Work?



A high frequency (20-35KHz) induction coil underneath the ceramic top plate heats the cooking utensil by magnetic friction. The heat is produced directly within the pan and is controlled by an electronic circuit which offers superior performance and functions.



During cooking, no energy is lost between the hob and the food. When the unit is switched off, or the pan is removed, cooking and heating stops immediately.



GENERAL INSTALLATION INSTRUCTIONS

This unit has been inspected and tested at the factory prior to shipment.

Unpack the unit and remove all packing materials. Place on a flat horizontal surface at the desired location.

 **WARNING:** Check the data plate on this unit before installation. Connect the unit only to the voltage and frequency listed on the data plate. Connect only to 1 or 3 phase as listed on the data plate. 

 **WARNING: IMPROPER GROUNDING COULD RESULT IN ELECTRICAL SHOCK!** This appliance is equipped with a three prong (grounded) plug for your protection against electrical shock hazard and should be plugged directly into a properly grounded three prong receptacle. Do not cut or remove the grounding prong from this plug. 

 **CAUTION:** Do not use ordinary steel wool as any particles left on the surface will rust. 

NEVER USE a wire brush, steel or abrasive scouring pads (except stainless), scraper, file or other steel tools. Surfaces which are marred collect dirt more rapidly and become more difficult to clean. Marring also increases the possibility of corrosive attack.

NEVER use any corrosive cleaner. Use only cleaners approved for stainless steel.

NEVER use cleaning solvents with a hydrocarbon base.

PRECAUTION BEFORE USING YOUR INDUCTION HOT PLATE

1. The ceramic top is of strong and non-porous properties. In case of breakage, even if it's only slightly cracked, disconnect the unit from the main power supply and contact a local service technician.
2. The unit is equipped with a "SMALL OBJECT DETECTOR". It is recommended not to place metal kitchen utensils, pan lids, knives or other such objects on the heating zone. If the unit is turned on, there is a risk that the utensils may become hot.
3. DO NOT place credit cards or other magnetic sensitive objects on the ceramic top.
4. Tests have shown that the induction presents no danger whatsoever for persons using a pacemaker. It is recommended that a distance of 24 inches be maintained whilst using the induction unit.
5. To prevent from overheating, DO NOT place aluminum-foil on the ceramic top.
6. Put the unit on a flat and even surface, but allow a space from the wall or other objects of at least 2-4 inches to allow for proper ventilation.
7. Immediate clean-up is recommended when any spillage occurs.

GENERAL INSTALLATION

1. Always clean equipment thoroughly before first use. (See general cleaning instructions)
2. Check ratings label for your model designation and electrical ratings.
3. For best results, use stainless steel countertops.

GENERAL CLEANING INSTRUCTIONS

1. Never clean any electrical unit by immersing it in water. Turn the unit off and allow it to cool before surface cleaning.
2. Always clean equipment thoroughly before first use. Clean unit daily. Use warm, soapy water. Mild cleansers and plastic scouring pads may be used to remove baked-on food and water scale on metal unit.
3. Unplug electrical unit before cleaning or servicing. All service should be performed by an APW Wyott authorized service agency.

NOTE: THIS APPLIANCE SHALL NOT BE CLEANED WITH A WATER JET.

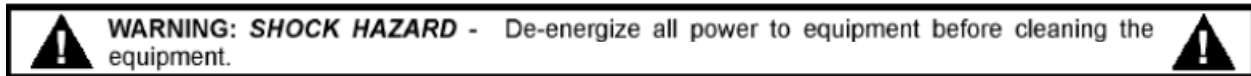

GENERAL TROUBLESHOOTING

If the unit fails to operate, check the following:

1. Is the unit connected to a live power source?
2. Check the circuit breaker.
3. Is the power switch on and pilot light glowing?
4. Check the data plate. Are you operating the unit on the proper voltage?

If the above checks out and you still have problems, call an APW Wyott authorized service agency.

NOTICE: Service work should be performed only by a qualified technician who is experienced in and knowledgeable with the operation of commercial gas, electric and steam cooking equipment. Contact the Authorized Service Agency for reliable service, dependable advice or other assistance and for genuine factory parts.

Warranty will be void and the manufacturer is relieved of all liability if:

- (A) Service work is performed by other than an APW Wyott Authorized Service Agency
- Or
- (B) Other than Genuine APW Wyott replacement parts are installed.

A current listing of all authorized APW Wyott authorized parts/service distributors is included with this product manual at the time of shipment. In the absence of this list you can call the APW Wyott 24 hour Service Hot Line which gives access to the nearest Authorized APW Wyott parts/service distributor. Call 1(800)733-2203.

SERVICE

Service work should be performed only by a qualified technician who is experienced in and knowledgeable with the operation of commercial gas, electric and steam cooking equipment. Contact the Authorized Service Agency for reliable service, dependable advice or other assistance and for genuine factory parts.

IF THE SUPPLY CORD IS DAMAGED, IT MUST BE REPLACED BY THE MANUFACTURER OR ITS SERVICE AGENT OR A SIMILARLY QUALIFIED PERSON IN ORDER TO AVOID A HAZARD.

USE AND CARE INSTRUCTIONS – IMPORTANT SAFEGUARDS

1. **DO NOT** block the air-intake panel, as this may overheat the unit.
2. We recommend pans to be in the range of 4-10 inches in diameter. Please refer to the next page for a list of suitable and unsuitable pans.
3. **DO NOT** touch the hot surface of the ceramic plate. **NOTE:** The induction unit itself does not produce any live heat during cooking, however, the heat reflected from the pan will leave the surface of the ceramic hot!
4. **DO NOT** cook with empty pots or pans. Heating an empty pan will automatically activate the overheating protection device and the unit will shut off.
5. Place the induction unit on a flat & even surface and at least 4 inches away from the wall and other objects for proper ventilation
6. **DO NOT** place any objects or tools in the air-intake panel. Doing so may cause electrical shock.
7. To protect against electrical shock, **DO NOT** immerse the unit, the cord or the plug in or near water or other liquids.
8. Close supervision is necessary when the induction unit is used or near children.
9. **DO NOT** operate the induction unit if it has been damaged in any manner or if the unit malfunctions. Return the unit to the nearest authorized service facility for examination or repair.
10. The use of any accessories or parts not recommended by the manufacturer may cause injuries.
11. Keep the power cord away from heat.
12. **DO NOT** place the induction unit in, on, or near open flames, electric burners, heated ovens or other high temperature surroundings.
13. **DO NOT** heat any sealed cans on the induction unit. A heated can may explode.
14. **DO NOT** move the induction unit while cooking or when the pan is hot.
15. After the induction unit has cooled down, unplug the cord and clean as follows,
CERAMIC PLATE: wipe with damp cloth or use a mild, non-abrasive cleaning solution.
BODY: wipe the control panel with soft cloth or use a mild cleaner.
16. **DO NOT** use induction unit for other than intended use.
17. Unplug when not in use.
18. When storing, **DO NOT** place any objects on top of the induction unit.
19. If the supply cord is damaged, it must be replaced by the manufacturer, its service agent or similarly qualified persons in order to avoid a hazard.

SAVE THESE INSTRUCTIONS!!!

SAFETY DEVICES

Safety Device

To comply with CE safety regulations there are two steps to turn on the induction unit.

First step: Push power ON/OFF key.

Second step: Within 5 seconds, turn power regulating knob OR push temperature select key "+", "-".

Automatic Safety Shut-Off,

If the induction unit is left on for more than 60 seconds without a pan or with an incompatible pan, the unit will automatically shut off.

Material Compatibility Detector

If the pan's material or it's dimensions are not suitable for the induction unit, the power indicator light will not light.

Small Object Detector

The induction unit will not recognize any objects or utensils smaller than 5cm in diameter. For best results, use pans that are between 12cm and 26cm in diameter.

Overheating Protection Device.

If the temperature of the pan reaches 250oC, and the temperature remains for 60 seconds, the unit will shut off automatically, there will be a short warning sound.

SUITABLE POTS & PANS

1. Iron
2. Cast iron
3. Stainless steel
4. Enamelware

All pots and pans must have a magnetic bottom.

All pots and pans must have a flat bottom.

All pots and pans should have a diameter between 4 and 10 inches.

UNSUITABLE POTS & PANS

1. Pot with diameter below 4 inches
2. Stainless steel pans with aluminum bottom
3. Pottery
4. Glass pans
5. Aluminum pans
6. Bronze pans
7. Copper pots
8. Pans with feet

OPERATING INSTRUCTIONS

1. Ensure that the electrical supply matches with the electrical specifications on the data plate located on the back side of the unit.
2. Place suitable pan on the center of the ceramic top.
3. Press power ON/OFF key, HOB indicator lamp will light.
4. Turn power knob or press one of the pre-set power keys [1, 4, 7 or 9] within 5 seconds.
5. LED power level will be displayed.
6. Adjust power level as needed.

NOTE

When the unit has been turned 'ON' the heating indicating light will be on. This indicates that the pan is heating.

If the indicating light is OFF and there is a beeping noise this indicates that

- the pan is not suitable
- there is no pan on the ceramic top

The unit is equipped with an "OVERHEATING PROTECTION DEVICE". When the temperature of cookware base is too hot, the power will cut out. The heating indication light will flash indicating that the overheating function is on.

Once the temperature reduces, the power will automatically re-start.

CAUSE OF OVERHEATING

If an empty pan is placed on the ceramic top and the power level is at maximum the ceramic surface will reach a high temperature very quickly. Once the pan is removed from the unit or food/ liquid is added to the pan, the surface temperature of the ceramic top will reduce very rapidly.

CONTROL PANEL

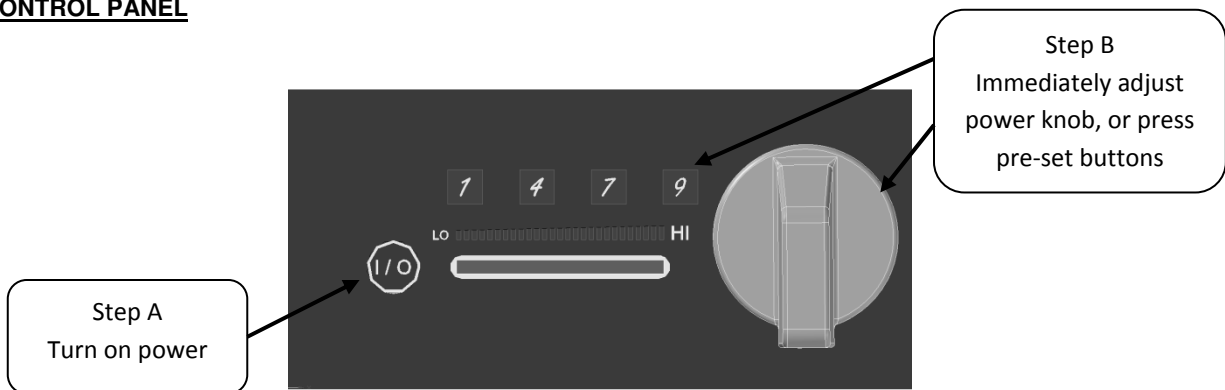

SPECIFICATIONS

MODEL	WIDTH	DEPTH	HEIGHT	VOLTAGE	PHASE	AMPS
IHP-1	17"	24-1/2"	12-7/8"	208/240	1	13/15
IHP-2	17"	32-3/8"	12-7/8"	208/240	3	22 / 25
IHP-4 (2- cords)	34"	32-3/8"	12-7/8"	2 x 208/240	3	2 x 22/25

EXPLODED VIEW – IHP-2 SHOWN

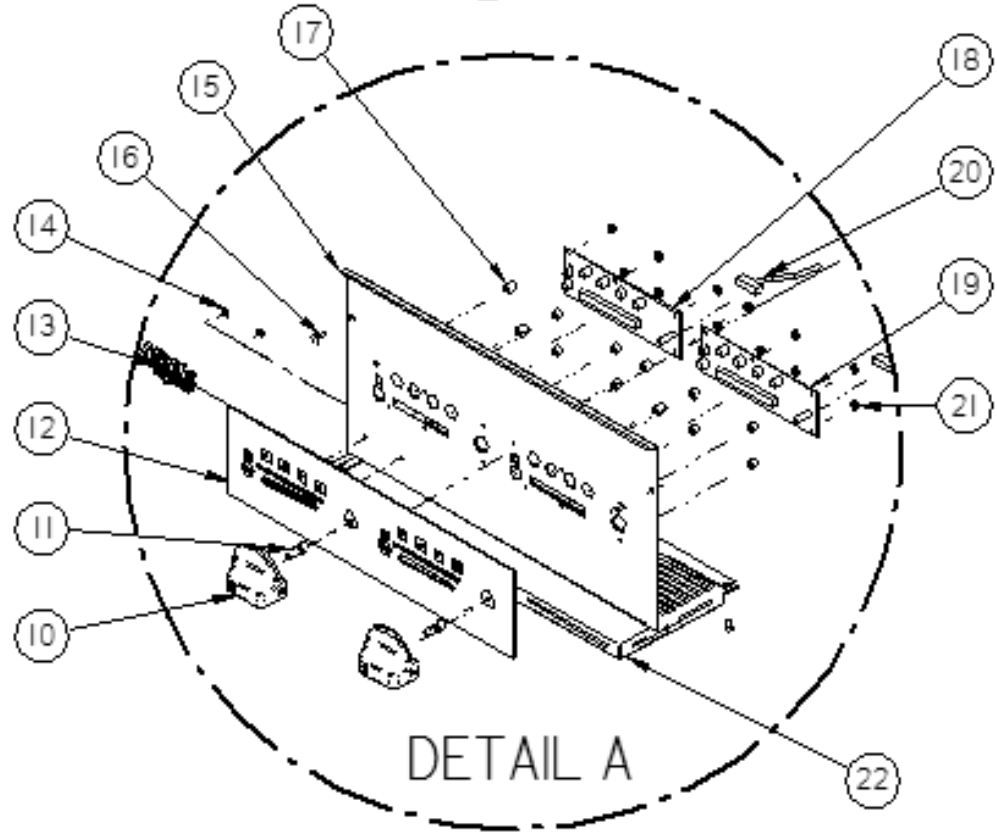
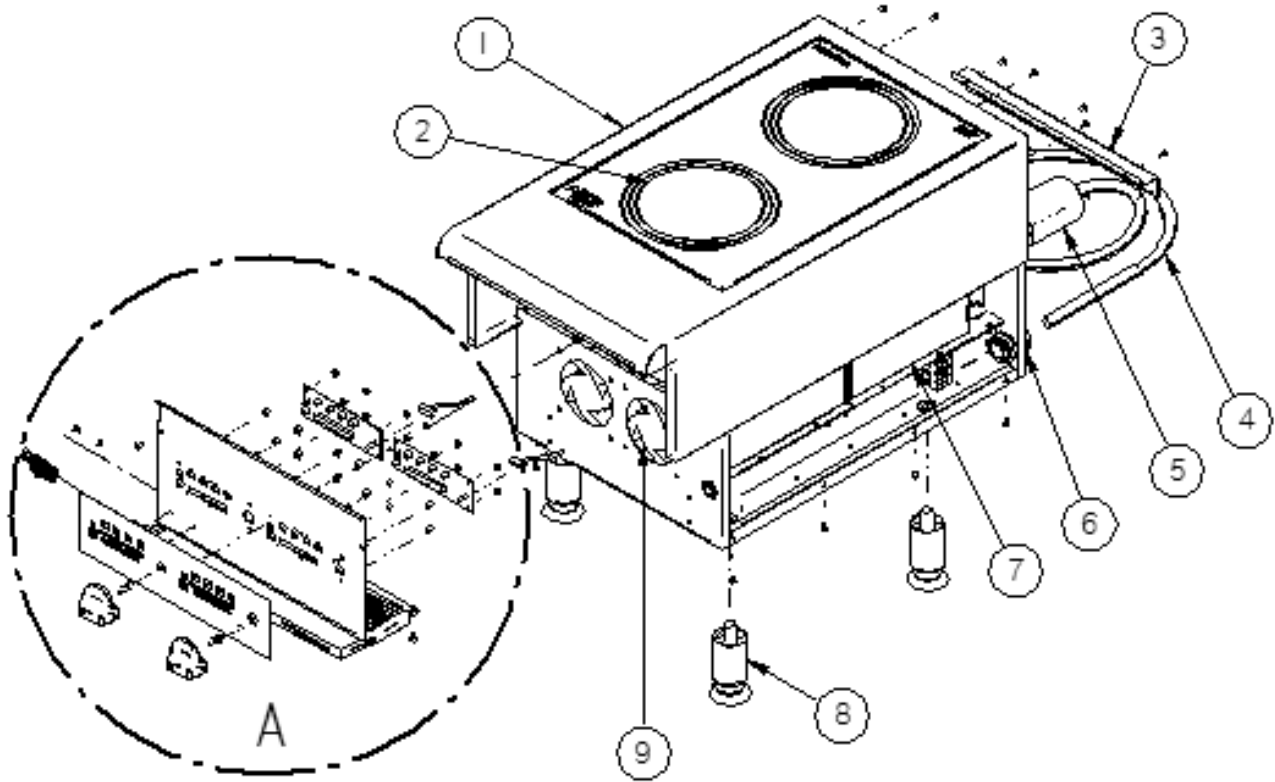

PARTS LIST – IHP

Item	IHP-1	IHP-2	IHP-4	DESCRIPTION	QTY (1/2/4)
1	25001174	25001074	25001471	SKIN, WELDMENT	1 / 1 / 1
2	25001160	25001060	25001060	GLASS, COOKTOP	1 / 1 / 2
3	25001081	-SAME-	-SAME-	SPACER, REAR FAN	1 / 1 / 2
4	1534610	1534000	1534000	CORDSET	1 / 1 / 2
5	NA	1607220	1607220	PLUG, NEMA L6-20P, 20A 250V	- / 1 / 2
6	8979200	21812798	21812798	STRAIN RELIEF	1 / 1 / 1
7	25001040	- SAME -	- SAME -	HOB, INDUCTION, 208/240V 2629/3500W	1 / 2 / 4
8	8633700	- SAME -	- SAME -	LEG, 2" DIAMETER, 4"ADJUSTABLE	4 / 4 / 4
9	1215400	- SAME -	- SAME -	FAN, COOLING, 220-240V	2 / 4 / 8
10	8706300	- SAME -	- SAME -	KNOB, .375 D SHAFT	1 / 2 / 4
11	25001055	- SAME -	- SAME -	INSERT, KNOB	1 / 2 / 4
12	25001151	25001051	25001051	DECAL	1 / 1 / 2
13	2065847	- SAME -	- SAME -	LOGO, APW WYOTT CASTED	1 / 1 / 1
14	8460900	- SAME -	- SAME -	PUSH NUT, 1/8"	2 / 2 / 2
15	25001185	25001285	25001485	CONTROL PANEL	1 / 1 / 1
16	8133800	- SAME -	- SAME -	SCREW, CONTROL PANEL	2 / 2 / 2
17	21877259	- SAME -	- SAME -	SPACER, CONTROL BOARD	6 / 12 / 24
18	25001045	- SAME -	- SAME -	CONTROL, FRONT HOB	1 / 1 / 2
19	NA	25001046	- SAME -	CONTROL, REAR HOB	- / 1 / 2
20	25001048	- SAME -	- SAME -	CABLE, CONTROL BOARDS	1 / 2 / 4
21	8100600	- SAME -	- SAME -	NUT, #4-40 KEPS	6 / 12 / 24
22	25001050	- SAME -	- SAME -	FILTER, AL MESH, 3-7/8" x 16-3/4" x 3/8"	1 / 1 / 2

WIRING SCHEMATIC – IHP-2 SHOWN

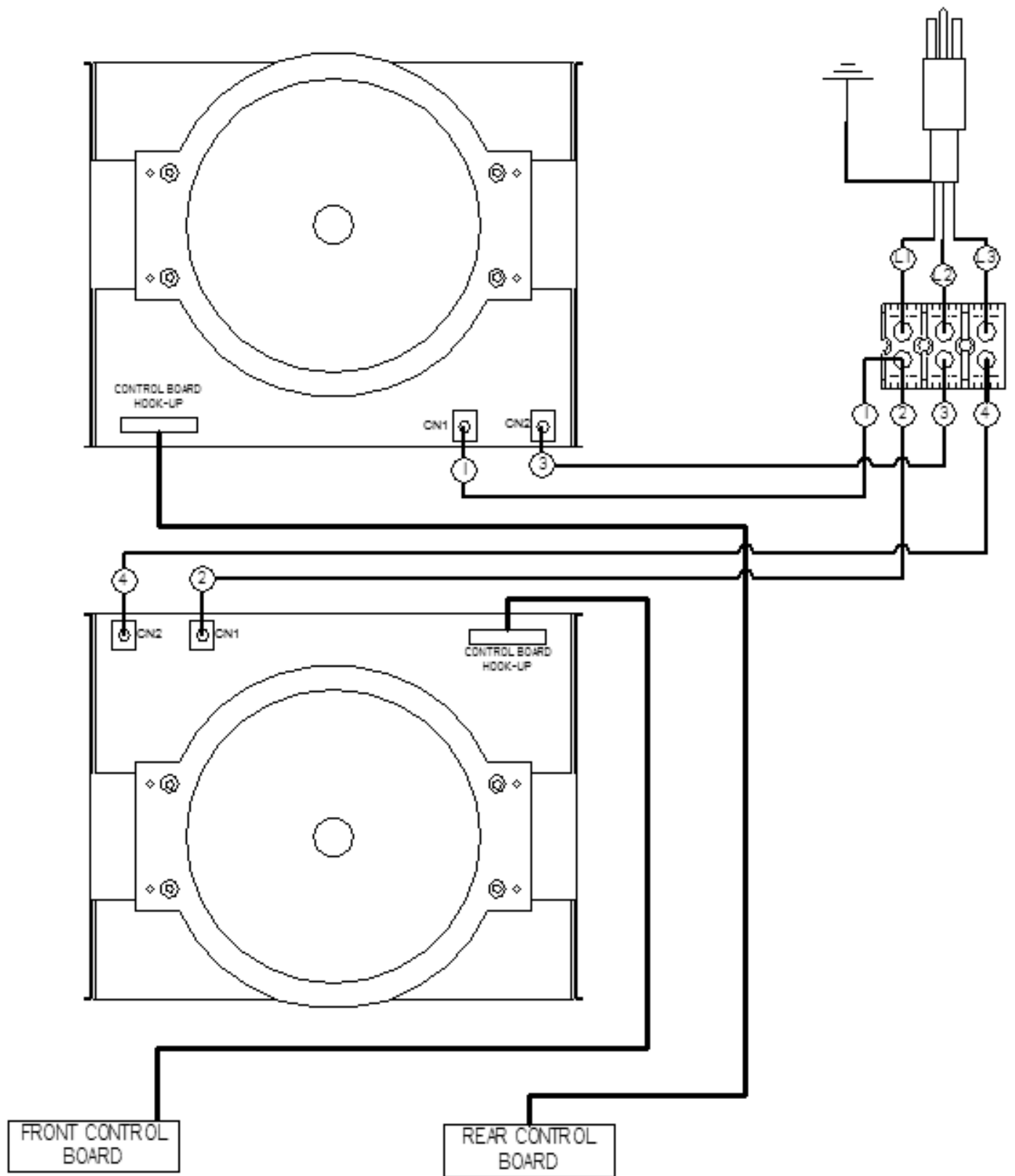

NOTES: _____

APW WYOTT EQUIPMENT LIMITED WARRANTY

APW Wyott Foodservice Equipment Company warrants its equipment against defects in materials and workmanship, subject to the following conditions:

This warranty applies to the original owner only and is not assignable.

Should any product fail to function in its intended manner under normal use within the limits defined in this warranty, at the option of APW Wyott such product will be repaired or replaced by APW Wyott or its Authorized Service Agency. APW Wyott will only be responsible for charges incurred or service performed by its Authorized Service Agencies. The use of other than APW Wyott Authorized Service Agencies will void this warranty and APW Wyott will not be responsible for such work or any charges associated with same. The closest APW Wyott Authorized Service Agent must be used.

This warranty covers products shipped into the 48 contiguous United States, Hawaii, metropolitan areas of Alaska and Canada. There will be no labor coverage for equipment located on any island not connected by roadway to the mainland.

Warranty coverage on products used outside the 48 contiguous United States, Hawaii, and metropolitan areas of Alaska and Canada may vary. Contact the international APW Wyott distributor, dealer, or service agency for details.

Time Period

One year for parts and one year for labor, effective from the date of purchase by the original owner. The Authorized Service Agency may, at their option, require proof of purchase. Parts replaced under this warranty are warranted for the un-expired portion of the original product warranty only.

Exceptions

- ***Gas/Electric Cookline:** Models GCB, GCRB, GF, GGM, GGT, CHP-H, EF, EG, EHP. Three (3) Year Warranty on all component parts, except switches and thermostats. (2 additional years on parts only. No labor on second or third year.)
- ***Broiler Briquettes, Rock Grates, Cooking Grates, Burner Shields, Fireboxes:** 90 Day Material Only. No Labor.
- ***Heat Strips:** Models FD, FDL, FDD, FDDL. Two (2) Year Warranty on element only. No labor second year.
- ***Glass Windows, Doors, Seals, Rubber Seals, Light Bulbs:** 90 Day Material Only. No Labor.

In all cases, parts covered by extended warranty will be shipped FOB the factory after the first year.

Portable Carry In Products

Equipment weighing over 70 pounds or permanently installed will be serviced on-site as per the terms of this warranty. Equipment weighing 70 pounds or under, and which is not permanently installed, i.e. with cord and plug, is considered portable and is subject to the following warranty handling limitations. If portable equipment fails to operate in its intended manner on the first day of connection, or use, at APW Wyott's option or its Authorized Service Agency, it will be serviced on site or replaced.

From day two through the conclusion of this warranty period, portable units must be taken to or sent prepaid to the APW Wyott Authorized Service Agency for in-warranty repairs. No mileage or travel charges are allowed on portable units after the first day of use. If the customer wants on-site service, they may receive same by paying the travel and mileage charges. Exceptions to this rule: (1) countertop warmers and cookers, which are covered under the Enhanced Warranty Program, and (2) toasters or rollergrills which have in store service.

Exclusions

The following conditions are not covered by warranty:

- *Equipment failure relating to improper installation, improper utility connection or supply and problems due to ventilation.
- *Equipment that has not been properly maintained, calibration of controls, adjustments, damage from improper cleaning and water damage to controls.
- *Equipment that has not been used in an appropriate manner, or has been subject to misuse or misapplication, neglect, abuse, accident, alteration, negligence, damage during transit, delivery or installation, fire, flood, riot or act of god.
- *Equipment that has the model number or serial number removed or altered.

If the equipment has been changed, altered, modified or repaired by other than an Authorized Service Agency during or after the warranty period, then the manufacturer shall not be liable for any damages to any person or to any property, which may result from the use of the equipment thereafter.

This warranty does not cover services performed at overtime or premium labor rates. Should service be required at times which normally involve overtime or premium labor rates, the owner shall be charged for the difference between normal service rates and such premium rates. APW Wyott does not assume any liability for extended delays in replacing or repairing any items beyond its control.

In all cases, the use of other than APW Wyott Authorized OEM Replacement Parts will void this warranty.

This equipment is intended for commercial use only. Warranty is void if equipment is installed in other than commercial application.

Water Quality Requirements

Water supply intended for a unit that has in excess of 3.0 grains of hardness per gallon (GPG) must be treated or softened before being used. Water containing over 3.0 GPG will decrease the efficiency and reduce the operation life of the unit.

Note: Product failure caused by liming or sediment buildup is not covered under warranty.

"THE FOREGOING WARRANTY IS IN LIEU OF ANY AND ALL OTHER WARRANTIES EXPRESSED OR IMPLIED INCLUDING ANY IMPLIED WARRANTY OF MERCHANTABILITY OR FITNESS FOR PARTICULAR PURPOSES AND CONSTITUTES THE ENTIRE LIABILITY OF APW WYOTT. IN NO EVENT DOES THE LIMITED WARRANTY EXTEND BEYOND THE TERMS STATED HEREIN."

9/05